

D3O® CP1 L1

D3O® CP1 L1

D3O uses patented, patent-pending and proprietary technologies to make rate-sensitive, soft, flexible materials with high shock absorbing properties.

The D3O® CP1 L1 chest protector features a low-profile, optimised material and new geometry combination to provide maximum ventilation and protection for the 2-wheel market. Its winged, tapered design offers additional rib protection and discreet integration into jackets.

PRODUCT FEATURES

- D3O® patented technology
- Certified to exceed the performance requirements of EN 1621-3:2018 Level 1, including optional cold test at -10°C
- UKCA Certified
- Ventilation offering superior breathability
- Available in full chest or divided chest
- Winged design
- Type B offering maximum coverage

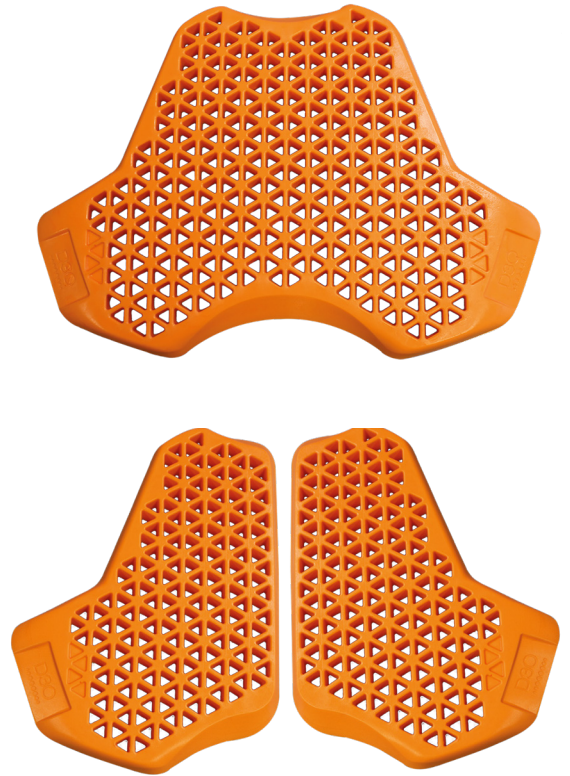

PAD INTEGRATION EXAMPLE



FULL OR DIVIDED MODULES

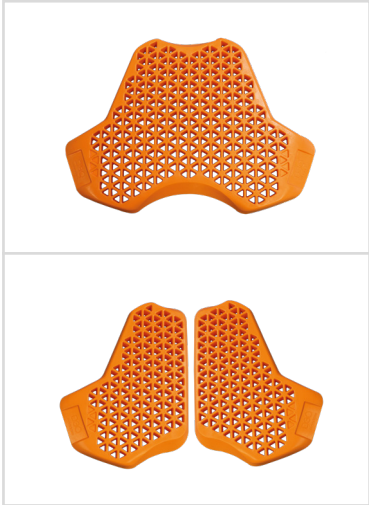

SUPERIOR BREATHABILITY

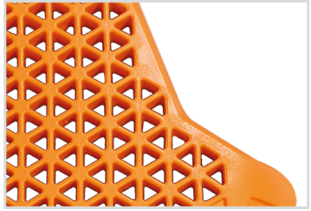

WINGED DESIGN

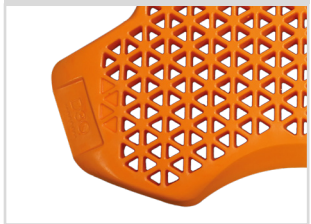

©2019 Design Blue Limited. All rights reserved.

Values shown represent typical product characteristics. For full details including material properties and product tolerances, please request SOQ document from D3O representative. The information provided is not intended to and does not create any warranties, expressed or implied, including any warranty of merchantability of fitness for a particular purpose. In accordance with the Company's policy of continuous improvement, D3O reserves the right to apply such improvements to its products and materials without notice. This data sheet shall not be reproduced or amended without the written consent of Design Blue Limited.

For more information on the D3O® CP1 L1, please contact your D3O Business Development Manager

TRUSTED IMPACT PROTECTION™

D3O® CP1 L1

FULL

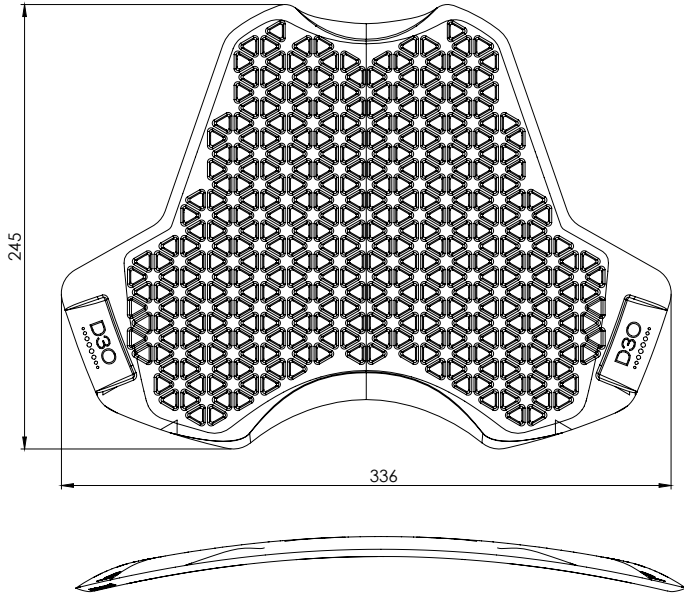

DIVIDED

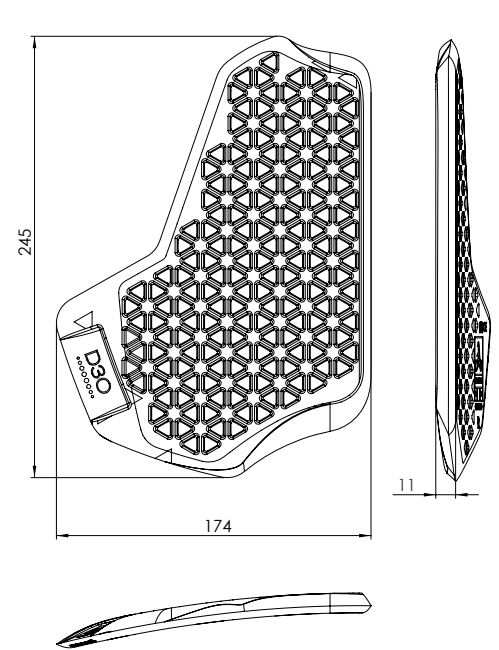

D3O® CP1 L1 - Product details

Product Name	D3O® CP1 L1 F	D3O® CP1 L1 D R	D3O® CP1 L1 D L
Product Code	12860	12858	12859
Material Code	SF001	SF001	SF001
Dimensions (mm)	245 x 336	245 x 174	245 x 174
Thickness (mm)	11	11	11
Weight (g)	168	89.8	89.8

D3O® CP1 L1 - Tested to EN 1621-3:2018 Level 1

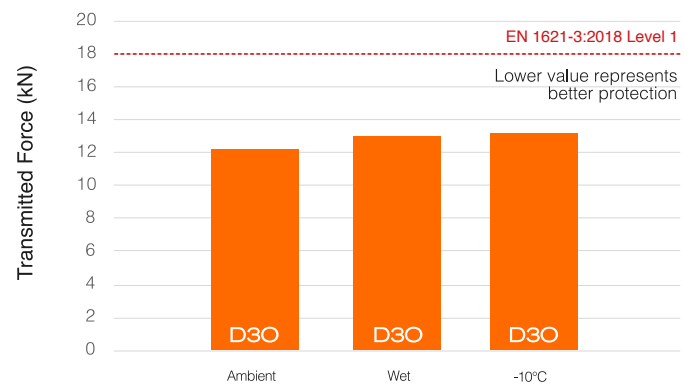

©2019 Design Blue Limited. All rights reserved.

Values shown represent typical product characteristics. For full details including material properties and product tolerances, please request SOQ document from D3O representative. The information provided is not intended to and does not create any warranties, expressed or implied, including any warranty of merchantability of fitness for a particular purpose. In accordance with the Company's policy of continuous improvement, D3O reserves the right to apply such improvements to its products and materials without notice. This data sheet shall not be reproduced or amended without the written consent of Design Blue Limited.

TRUSTED IMPACT PROTECTION™